



# CMV7101 Low Power, Low Voltage OPAMP with RRIO, SOT23-5

### Features

- Tiny SOT23-5 Package
- Guaranteed specs at 2.2V and 3V
- Very Low Supply current, typically 300µA
- Rail-to-Rail Input and Output (RRIO)
- Typical Total Harmonic Distortion of 0.01% at 3V
- 1MHz Typical Gain-Bandwidth Product
- Input common mode range includes V- and V+

### Applications

- Mobile Communications
- Cellular Phones
- Battery operated Systems
- Notebooks and PDAs
- Electronic Toys

### Product Description

The CMV7101 is a high performance CMOS operational amplifier available in a small SOT23-5 package. Operating with very low supply current, it is ideal for battery operated applications where power, space and weight are critical.

Performance is superior to the industry standard "7101" SOT Amp. With enhancements of very low supply current, typically 300µA, much higher output drive current, and further enhanced operation at very low 2.2V supply voltage compared to our CMC7101 at 2.7V supply voltage, the CMV7101 is the economical solution for 3V applications.

Ideal for use in personal electronics such as cellular handsets, pagers, cordless telephones and other products with limited space and battery power.

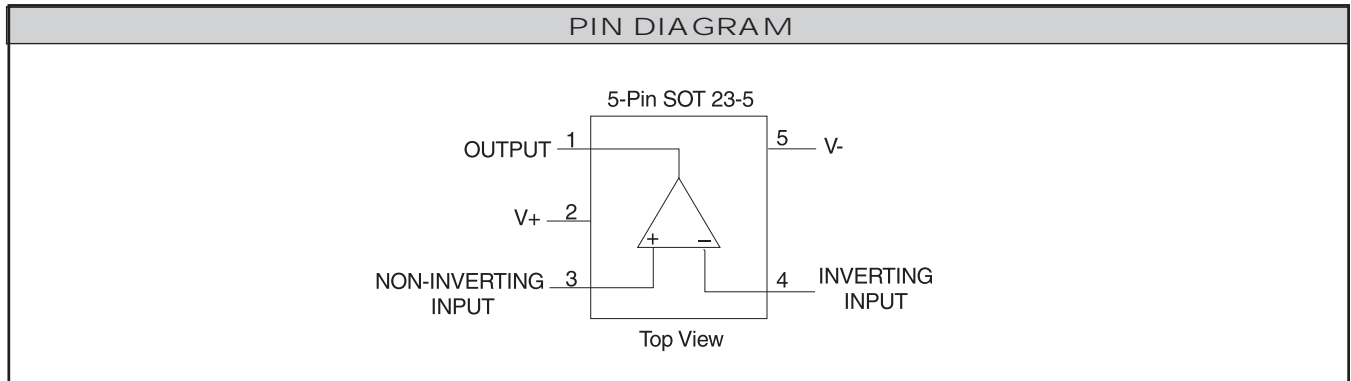

STANDARD PART ORDERING INFORMATION				
Package		Ordering Part Number		
Pins	Style	Tubes	Tape & Reel	Part Marking
5	SOT23-5	CMV7101Y/T	CM7101Y/R	V101



ABSOLUTE MAXIMUM RATINGS (Note 1)		
Parameter	Rating	Units
ESD Tolerance (see Note 2)	2,000	V
Differential Input Voltage	± Supply Voltage	V
Voltage at Input / Output Pin	(V+) + 0.3V, (V-) -0.3V	V
Supply Voltage (V+ to V-)	7.5	V
Current at Input Pin	5	mA
Current at Output Pin (see Note 3)	35	mA
Current at Power Supply Pins	35	mA
Lead Temperature (soldering, 10 sec.)	260	°C
Storage Temperature Range	-65 to +150	°C
Junction Temperature (see Note 4)	150	°C

OPERATING CONDITIONS (unless specified otherwise)		
Parameter	Rating	Units
Supply Voltage	$2.2 \leq V+ \leq 7$	V
Junction Temperature Range	$-40 \leq T_J \leq +85$	°C
Thermal Resistance	325	°C / W

**2.2V ELECTRICAL OPERATING CHARACTERISTICS**

Unless otherwise specified, all limits guaranteed for  $T_J=25^\circ\text{C}$ ,  $V+ = 2.2\text{V}$ ,  $V- = 0\text{V}$ ,  $R_L > 1\text{M}\Omega$

Symbol	Parameter	Conditions	TYP	LIMIT	UNIT
$V_{OS}$	Input Offset Voltage	$V_{OUT} = 1.1\text{V}$	0.11	8	mV
$TCV_{OS}$	Input Offset Voltage Average Drift		1		$\mu\text{V}/^\circ\text{C}$
$I_B$	Input Bias Current		1		pA
$I_{OS}$	Input Offset Current		0.5		pA
$R_{IN}$	Input Resistance		1		$\text{T}\Omega$
CMRR	Common-Mode Rejection Ratio	$0.2 < V_{CM} < 2.0\text{V}$	60	50	dB
$V_{CM}$	Input Common Mode Voltage Range	$V+ = V$	0	0.2	V
		For CMRR > 50dB	2.2	2.0	V
PSRR	Power Supply Rejection Ratio	$V+ = 1.35\text{V to } 1.65\text{V}$ $V- = -1.35\text{V to } -1.65\text{V}$ $V_{CM} = 0$	60	50	dB
$C_{IN}$	Common-Mode Input Capacitance		3		pF
$V_O$	Output Swing	$R_L = 600\Omega$	2.1		V
			0.1		V
		$R_L = 2\text{K}\Omega$	2.1	1.8	V
			0.1	0.4	V
			2.15	2.0	V
$I_S$	Supply Current		0.25	0.80	mA
			0.02	0.2	V
SR	Slew Rate		0.6		$\text{V}/\mu\text{s}$
GBW	Gain Bandwidth Product		0.7		MHz



## 3V ELECTRICAL OPERATING CHARACTERISTICS

Unless otherwise specified, all limits guaranteed for  $T_J=25^\circ\text{C}$ ,  $V_+ = 3\text{V}$ ,  $V_- = 0\text{V}$ ,  $R_L > 1\text{M}\Omega$ 

Symbol	Parameter	Conditions	TYP	LIMIT	UNIT
$V_{OS}$	Input Offset Voltage	$V_{OUT} = 1.5\text{V}$	0.11	4	mV
$TCV_{OS}$	Input Offset Voltage Average Drift		1		$\mu\text{V}/^\circ\text{C}$
$I_B$	Input Bias Current		1		pA
$I_{OS}$	Input Offset Current		0.5		pA
$R_{IN}$	Input Resistance		1		$\text{T}\Omega$
CMRR	Common-Mode Rejection Ratio	$0 < V_{CM} < 3\text{V}$		55	dB
$V_{CM}$	Input Common Mode Voltage Range	$V_+ = V$	0.0	0.0	V
		For CMRR > 50dB	3.3	3.0	V
PSRR	Power Supply Rejection Ratio	$V_+ = 1.5\text{V to } 1.8\text{V}$ $V_- = -1.5\text{V to } -1.8\text{V}$ $V_{CM} = 0$	80	68	dB
$C_{IN}$	Common-Mode Input Capacitance		3		pF
$V_O$	Output Swing	$R_L = 600\Omega$	2.9	2.6	V
			0.1	0.4	V
		$R_L = 2\text{K}\Omega$	2.9	2.6	V
			0.1	0.4	V
		$R_L = 10\text{K}\Omega$	2.99	2.7	V
			0.01	0.3	V
$I_S$	Supply Current		0.3	0.81	mA
SR	Slew Rate		0.9		$\text{V}/\mu\text{s}$
GBW	Gain Bandwidth Product		1.0		MHz
$I_{SC}$	Output Short Circuit Current	Sourcing $V_O = 0\text{V}$ (see Note 5)		16	mA
		Sinking $V_O = 3\text{V}$ (see Note 5)		11	mA
T.H.D.	Total Harmonic Distortion	$F = 10\text{KHz}$ , $A_v = -2$ $R_L = 10\text{K}\Omega$ , $V_O = 2.0\text{Vpp}$	0.01		%

**Note 1** Absolute Maximum Ratings indicate limits beyond which damage to the device may occur. Operating conditions indicate ratings for which the device is intended to be functional, but specific performance is not guaranteed. For guaranteed specifications and the test conditions, see the Electrical Operating Characteristics.

**Note 2** Human Body Model, 1.5KW in series with 100pF.

**Note 3** Applies to both single-supply and split-supply operation. Continuous short ckt operation at elevated ambient temperatures can result in exceeding the maximum allowed junction temperature of  $150^\circ\text{C}$ .

**Note 4** The maximum power dissipation is a function of  $T_{J(MAX)}$ ,  $\theta_{JA}$ , and  $T_A$ . The maximum allowable power dissipation at any ambient temperature is  $P_D = (T_{J(MAX)} - T_A) / \theta_{JA}$ . All numbers apply for packages soldered directly to a PC board.

**Note 5** See Application Section.

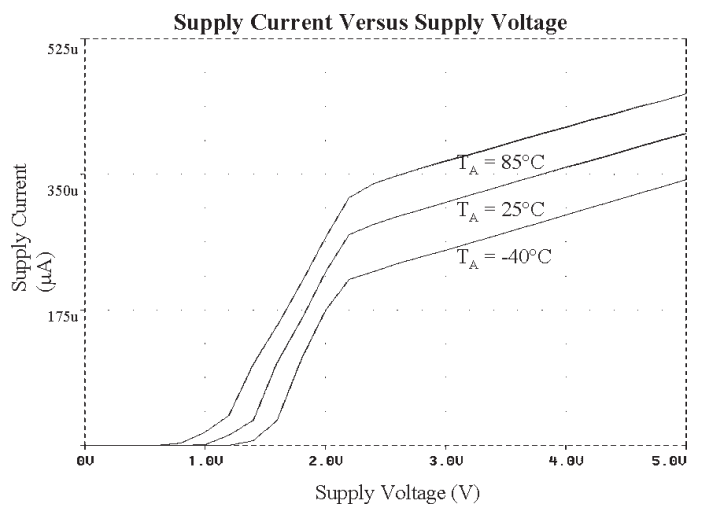
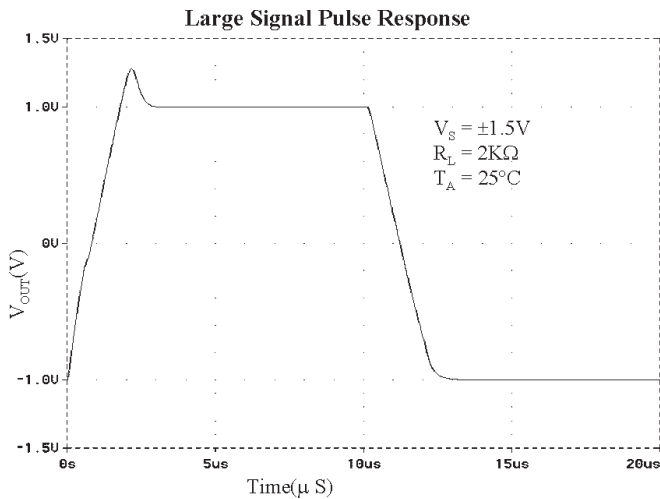
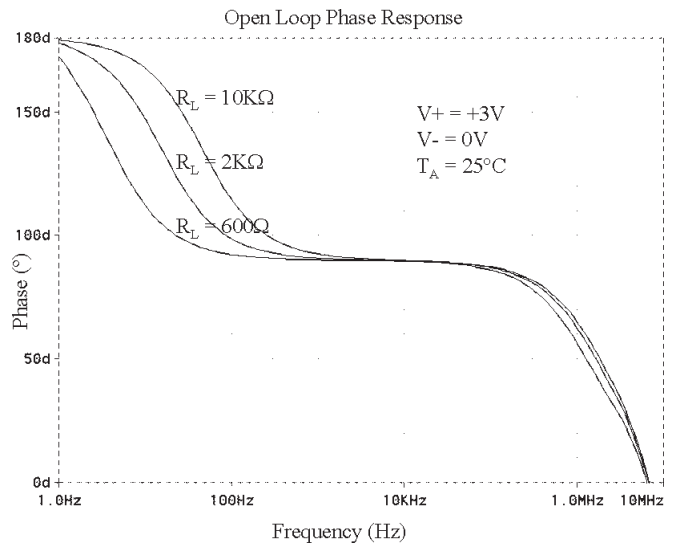
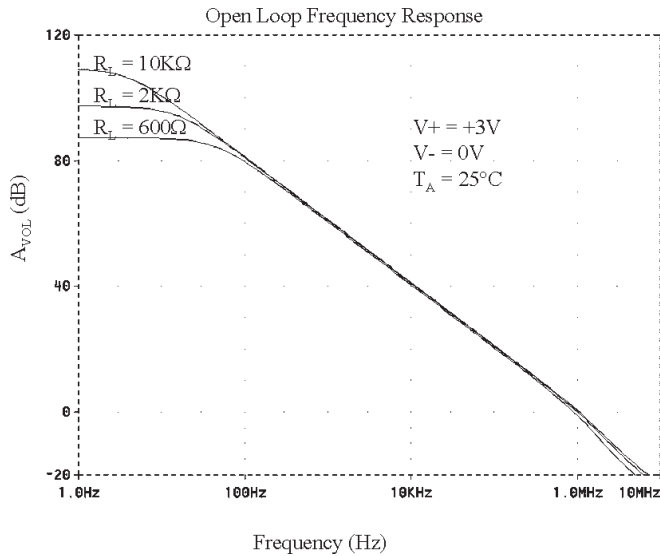
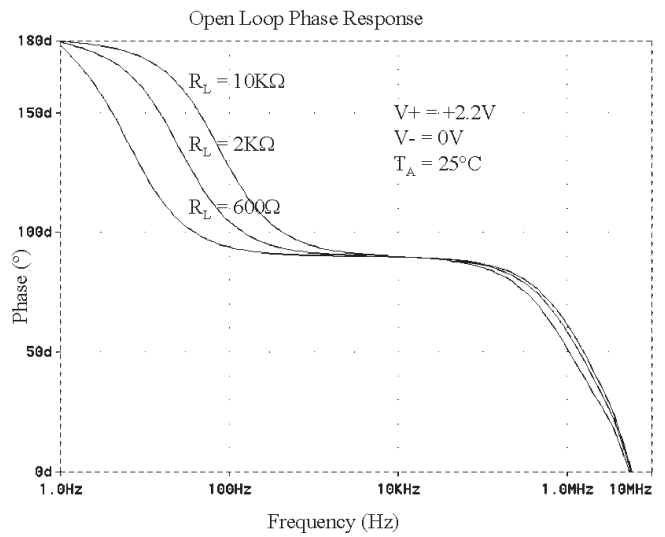
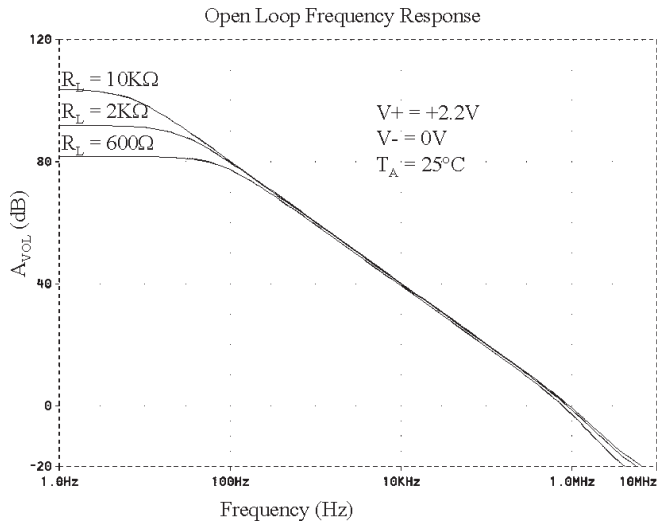

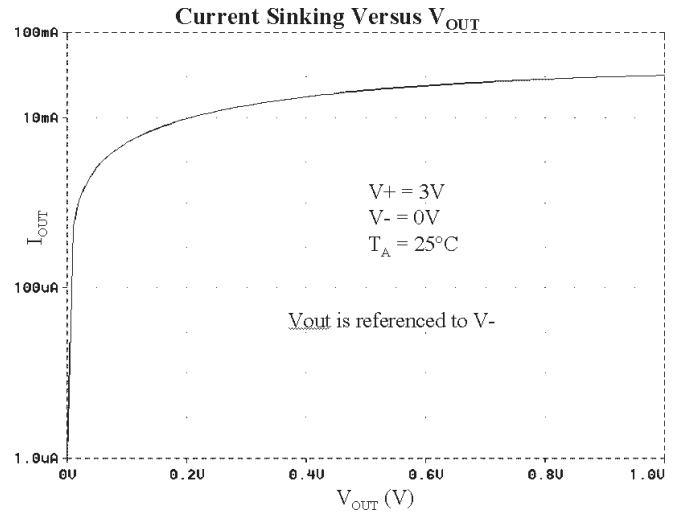
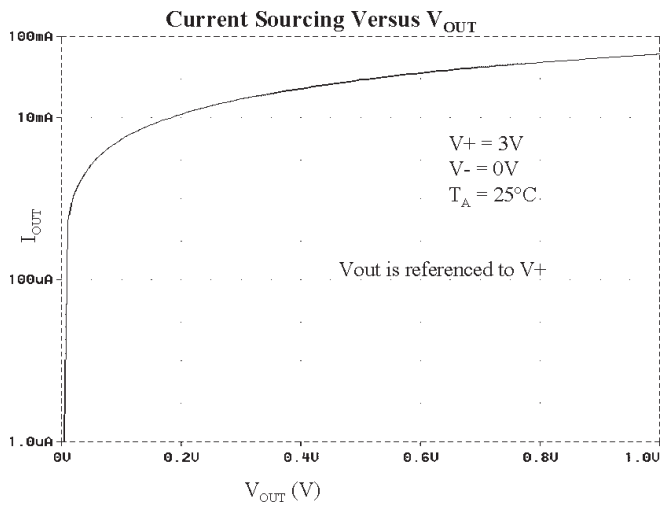
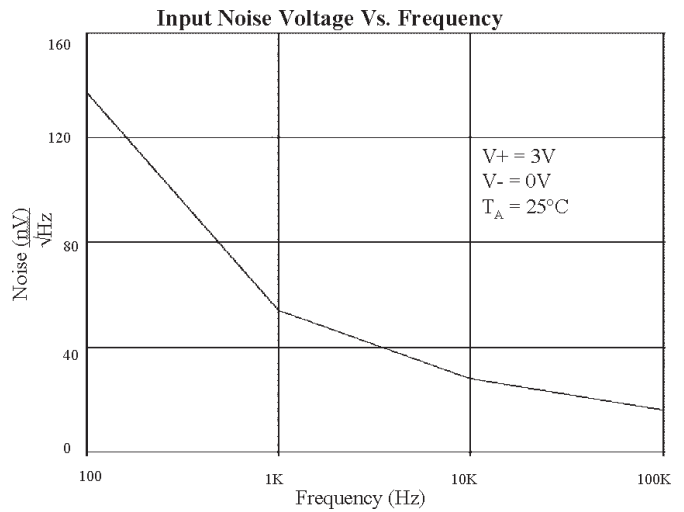
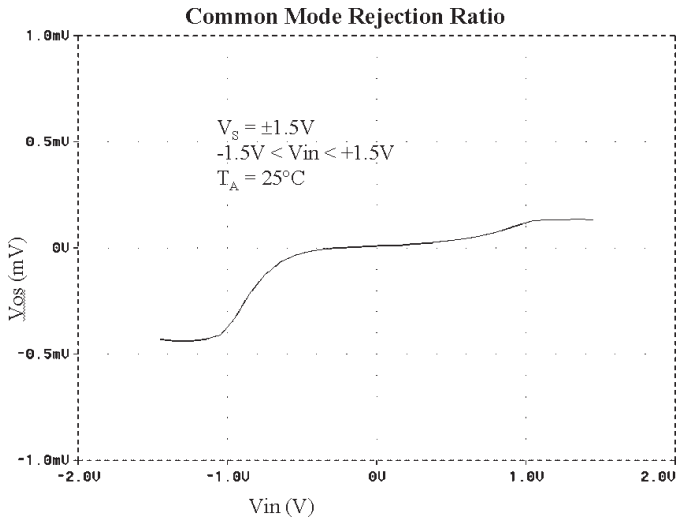
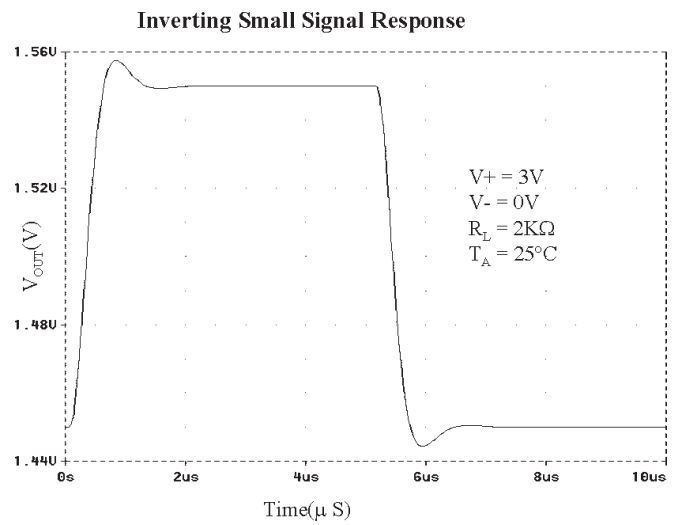
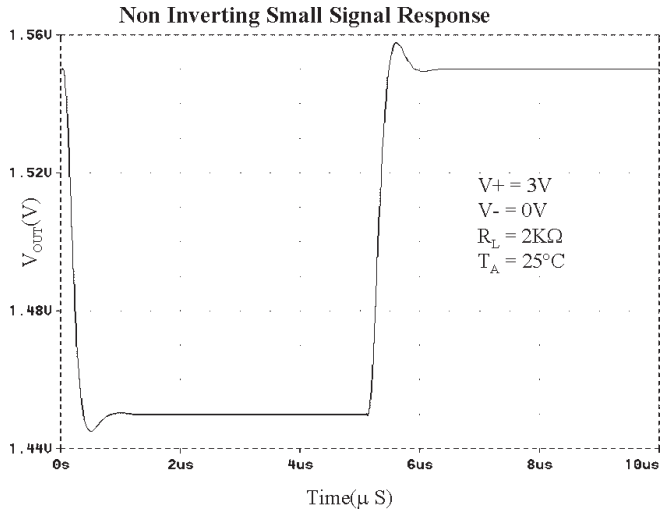



**Applications Benefits**

**1.0 Packaging**

The most obvious benefit to using the CMV7101 is the SOT package, which has been widely accepted as the surface mounting of choice. The SOT23 footprint not only saves space on the PCB but also provides a low profile for applications such as the PCMCIA, type III cards which require heights less than 0.056 Inches (1.43 mm).

**1.2 Signal Integrity**

As systems have become smaller and higher functionality is demanded of them, spacing between traces has diminished as well. This can result in increased sensitivity to noise, pick-up, and cross talk. Due to its small size, the CMV7101 may be placed in close proximity to the signal source minimizing the above problems, and since it is a single device, routing traces to a multiple amplifier such as dual or quad avoids running long traces reducing cross talk.

The Rail to Rail Inputs and Output allow the amplifier to operate on a low supply voltages while maintaining signal tracking integrity and large output voltage swings (relative to the supply rail).

**1.3 Low Distortion**

Even when operated from a 2.2 volt supply, the CMV7101 still exhibits very low distortion thanks to its large open loop gain and unique circuit design making it suitable for application in many audio systems.

**1.4 Low Supply Current and High Output Current**

The supply current required by CMV7101 of 300  $\mu$ A coupled with its ability to sink and source large currents of 50 mA make it unique in its class. Clearly, the low supply current provides longer operation in battery operated systems while the high output current assures that circuits with capacitive loads will “starter” faster. The high output current also eliminates the need for a buffer, such as an emitter follower, in the loop with the amplifier for applications demanding large load currents.

**Applications Information**

**2.0 Input Common Mode and Output Voltage Considerations**

The CMV7101 will accommodate input common mode voltages equal to both rails, and input signals that exceed the rails will not cause phase inversion of the output. However, ESD diode clamps are provided at the inputs

that can be damaged if currents in excess of 5 mA when the input voltage exceeds the rail by 0.3 volt. Damage can be precluded by inserting a limiting resistor,  $R_s$ , in series with the input whose recommend value may be calculated from:

$$R_s > \frac{V_{in} - (V+ - 0.3 V)}{5 \text{ mA}} \quad (1)$$

For  $V+$  equal to 2.2 volts, and  $V_{in}$  equal to a maximum of 5 volts,  $R_s$  should be chosen for a value of 500  $\Omega$  or greater.

**2.1 Output Current and Power Dissipation**

The CMV7101 is capable of sinking or sourcing output currents in excess of 50 mA and voltages nearly equal to the supply voltage. The device does not have internal short circuit limiting, but it is capable of withstanding an indefinite short circuit without sustaining damage. Clearly the maximum power dissipation will occur under these conditions:

$$P_{diss} = (V+ - V_{out}) * I_{out} \quad (2)$$

Where:  $P_{diss}$  = Power dissipated by the chip  
 $V+$  = Supply Voltage  
 $V_{out}$  = The Output Voltage

Furthermore,

$$T_j = T_A + \theta_{JA} \quad (3)$$

Where  $T_A$  = The Ambient Temperature  
 $\theta_{JA}$  = The thermal impedance of the package

For a short circuit on the output with  $V+$  equal to 3 volts and an output current of 50 mA, the power dissipation per equation (2) would be 150 mW. Assuming a worst case ambient of 85  $^{\circ}$ C, the junction temperature would be 134  $^{\circ}$ C well below the maximum junction rating of 150  $^{\circ}$ C.

**2.2 Input Considerations**

The CMV7101 exhibits an input impedance which is typically in excess of 1 Tera W making it an excellent choice for applications requiring high source impedance such as buffering photo diodes, high impedance transducers, or long time constant integrators. A high source impedance usually dictates a large feedback resistor,  $R_f$ , but the parallel combination of  $R_f$  and  $R_s$  in parallel with the input capacitance of the amplifier (typically 3 pF) creates a parasitic pole which can erode the phase margin of the amplifier. The recommended fix is to bypass  $R_f$  with a small capacitor thus canceling the pole at the inverting input. The formula



for calculating invariably results in a value larger than optimum,

$$\frac{1}{2\pi R_s} > \frac{1}{2\pi R_f} \quad (4)$$

Since the parasitic capacitance is bound to change between the breadboard phase and the production printed circuit board, we recommend the use of a "gimmick" which is made by twisting two lengths (about a foot) of insulated wire (such as AWG 24) that are bared at both ends. The gimmick is soldered across  $R_f$ . With the circuit in operation,  $C_f$  is adjusted by clipping short lengths until the compensation is nominal. Then simply measure the capacitance of the gimmick on an impedance bridge.

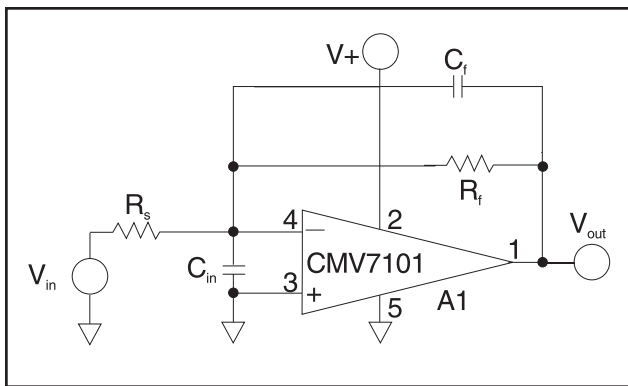

Figure 1. Input Capacitance Compensation

### 2.3 Capacitive Load Considerations

The CMV7101 is capable of driving capacitive loads in excess of 100 pF without oscillation. However, significant peaking will result. The easiest way to minimize this problem is to use an isolation resistor as shown in Figure 2.

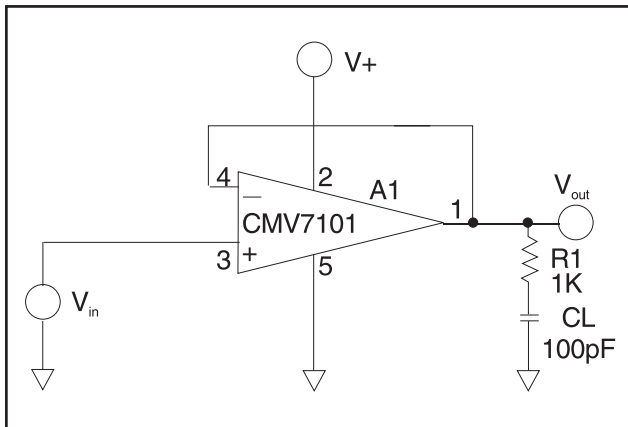

Figure 2. Isolating a Capacitive Load

### 2.4 Power Supply Decoupling

The CMV7101 is not prone to oscillation without the use of power supply decoupling capacitors, however to minimize hum and noise pick-up, it is recommended that the rails be bypassed with 0.01 μF capacitors.

### Typical Application

### 3.0 Low Power and Supply Voltage Single Rail Oscillator

Operational amplifiers have been used for years to generate frequency stable oscillators, but the circuit shown in Figure 3 provides a stable frequency operating from a single supply voltage and drawing a mere 300 μA. For  $(R_1 + R_2) \div R_1 = 0.473$ , the period, T, of the oscillator is given by:

$$T = 2 R_f C_1 \quad (5)$$

Where:  $R_f$  is the feedback resistor,  $C_1$  is the capacitor

The period is easily adjusted by varying  $R_f$ .  $R_3$  ensures that the circuit will start on a single rail by forcing  $A_1$ 's output to the positive rail.  $R_4$ 's value is not critical but should be a factor of 10 greater than the parallel combination of  $R_1$  and  $R_2$ .

The circuit lends itself to a variety of applications such as battery operated toys where a LED is required to flash at a periodic rate. The high output current of the CMV7101 assures that the LED will have sufficient current to turn it on.

$$\frac{R1}{R1 + R2} = 0.473$$

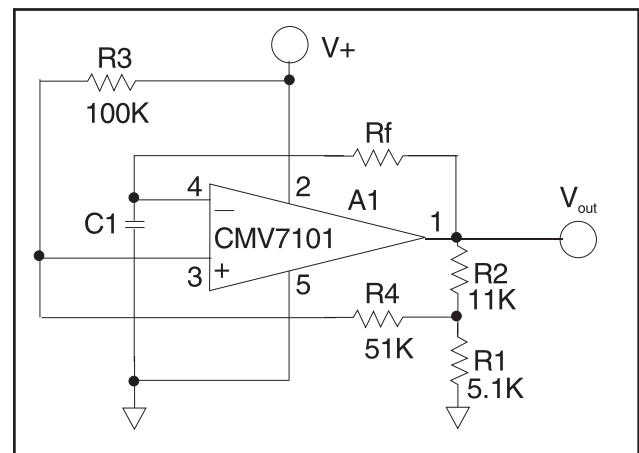

Figure 3. Single Rail Oscillator